



May 20 - 24, 2018
Makuhari Messe
Chiba, Japan



Exhibition Guidance

- Publishers Desk-
- University Panel-
- Science Society Desk-



Japan Geoscience Union

Outline of JpGU Meeting 2018

Outline

Name of the meeting	Japan Geoscience Union Meeting 2018
Date	May 20th (SUN) – 24th (THU) ,2018 for 5 days
Venue	Makuhari Messe International Conference Hall, International Exhibition Hall 7 / Tokyo Bay Makuhari Hall
Host	Japan Geoscience Union

Society Members

Japanese Society for Biological Sciences in Space, Japan Society of Engineering Geology, The Japanese Society of Hot Spring Sciences, The Oceanographic Society of Japan, The Volcanological Society of Japan, Society of Science on Form, Japan, Japanese Society for Active Fault Studies, Meteorological Society of Japan, Japan Association of Mineralogical Sciences, Japan Cartographers Association, The Palaeontological Society of Japan, The Japanese Association for Arid Land Studies, The Society of Resource Geology, The Seismological Society of Japan, Japan Society of Geoinformatics, Japanese Association of Hydrologic of Science, Japan Society of Hydrology & Water Resources, Society of Eco-Engineering, SEE, The Society for the Study of the Origin and Evolution of Life Japan, The Japanese Association for Petroleum Technology, The Japanese Society of Snow and Ice, The Geodetic Society of Japan, The Japan Society of Atmospheric Chemistry, Society of Atmospheric Electricity of Japan, The Sedimentological Society of Japan, Japan Association for Quaternary Research, Japan Society of Earth Science Education, The Association for the Geological Collaboration in Japan, Japanese Association of Groundwater Hydrology, The Geochemical Society of Japan, PALEO10: Paleosciences Society, Society of Geomagnetism and Earth, Planetary and Space Sciences, Japanese Geomorphological Union, The Geological Society of Japan, The Geothermal Research Society of Japan, The Japanese Society for Geographical Science, The Association of Japanese Geographers, The Geographic Education Society of Japan, The Association of Geography Educators of Japan, Geographic Information System Association of Japan, Tokyo Geographical Society, The Tohoku Geographical Association, Japanese society of soil physics, The Clay Science Society of Japan, The Society of Agricultural Meteorology of Japan, The Society of Exploration Geophysicists of Japan, The Japanese Society of Limnology, The Japanese Society of Physical Hydrology, The Remote Sensing of Society Japan, The Japanese Society for Planetary Sciences (As of February 28th, 2018)

Supporting Members

Regional city Convention attraction Promotion Council, FORTE Science Communication, ASO UNESCO GLOBAL GEOPARK, Crimson Interactive Japan, WorldCreations Inc , Japan Geoparks Network(JGN), American Journal Experts

Co-sponsor

The Astronomical Society of Japan, The Japanese Coral Reef Society, Japana Association for Earthquake Engineering, The Japan Landslide Society, The Japanese Geotechnical Society, Japan Society of Erosion Control Engineering, The Japan Society of High Pressure Science and Technology, Japan Society Of Civil Engineers

Sponsorship

Science Council of Japan / Ministry of Education, Culture, Sports, Science and Technology-Japan / Geospatial Information Authority of Japan / Meteorological Research Institute / Kakioka Magnetic Observatory, Japan Meteorological Agency
Hydrographic and Oceanographic Department, Japan Coast Guard / National Institute for Educational Policy Research
Hokkaido Research Organization / Japan Oil, Gas and Metals National Corporation / National Museum of Nature and Science / Japan Aerospace Exploration Agency / Japan agency for Marine-Earth Science and Technology / National Museum of Emerging Science and Innovation / Building Research Institute / National Institute for Environmental Studies, Japan / National Institute of Advanced Industrial Science and Technology (planned) / National Institute of Information and Communications Technology / Forestry and Forest Products Research Institute / Public Works Research Institute / Japan Atomic Energy Agency / Institute for Rural Engineering, NARO / National Institute for Materials Science
National Research Institute for Earth Science and Disaster Resilience / RIKEN / High Energy Accelerator Research Organization / National Astronomical Observatory of Japan / National Institute of Polar Research / The Institute of Statistical Mathematics / Research Institute for Humanity and Nature (planned) / Japan Geotechnical Consultants Association / The Institute of Electronics, Information and Communication Engineers / Tokyo Geotechnical Consultant Association / The Japan Society of Mechanical Engineers / The Japan Society for Aeronautical and Space Sciences
Japan Analytical Instruments Manufacturers' Association (planned) / Central Research Institute of Electric Power Industry
Japan Space Forum / Japan Map Center / Association for The Development of Earthquake Prediction / Research Institute of Innovative Technology for the Earth / Fukada Geological Institute / Japan Association of Surveyors / Chiba Convention Bureau and International Center / Chiba City / Chiba Prefectural Board of Education / Chiba City Board of Education

Outline of Exhibition

Outline

Name : JpGU Meeting 2018
 Publishers Desk/University Panel/Science Society Desk
 Data : May 20th (SUN) – 24th (THU) ,2018 For 5 days
 Venue: Makuhari Messe International Conference Hall 1&2F

Time Schedule

AM1 9:00AM-10:30AM
 AM2 10:45AM-12:15PM
 PM1 1:45PM- 3:15PM
 PM2 3:30PM- 5:00PM
 PM3 5:15PM- 6:30PM(Poster core time)

Schedule

May 19th (SAT)	The previous day	3:00 PM - 6:00PM	Carrying-in and Installation
20th (SUN)	The first day	8:00AM -10:00AM 10:00AM - 6:30PM	Carrying-in and Installation Show Hours
21st (MON) to 23rd(WED)	2nd to 4th day	10:00AM - 6:30PM	Show Hours
24th (THU)	The final day	10:00AM – 3:30PM 3:30PM – 5:00PM	Show Hours Dismantling

Deadline of Required Documents	2018	Deadline of Application for P.R.
-Release of this booklet	March	March 16th(FRI) - Banner on Mobile Apps - Program Book (A4 size booklet) - JGL(News Letter) - Paper Cup Advertising - Bar-code Scanner order March 30th(FRI) - Stamp Rally (Free)
April 13th (FRI) Applications of options - Order for optional items - Internet - Vehicle Pass	April	April 13th(FRI) - E-mail news (Free) April 27th(FRI) - Posting your Logo on the Top Page (Free) - Short Seminar
May 8th (TUE) Application for Exhibitor Pass May 17th (THU) Shipping notification	May	May 8th(TUE) - Digital signage

Please order through the online system
 JpGU Meeting 2018 website -> Information for Exhibitors -> For exhibitors [>> Log in]
<https://www.member-jpgu.org/exhibition-booth/login/>

Please refer P.15-17 of this booklet for more details.

Outline of Exhibition- 2

Contact (Inquiries)

About this booklet

About the venue, options, carrying-in and out

Makuhari Messe, Inc.

In charge of JpGU Meeting 2018 venue

Takeda (Ms.) , Watanabe (Mr.)

2-1, Nakase, Mihama-ku, Chiba-city, 261-8550 Japan

TEL: +81-43-296-0694 FAX: +81-43-296-0529

E-mail: exhibition@jpgu.org or jpgu@m-messe.co.jp

About meeting, exhibition, and general information

Japan Geoscience Union Office

2-4-16 Yayoi, Bunkyo-ku, Tokyo, 113-0032, Japan

TEL: +81-3-6914-2080 FAX: +81-3-6914-2088

Email: exhibition@jpgu.org

Venue Map

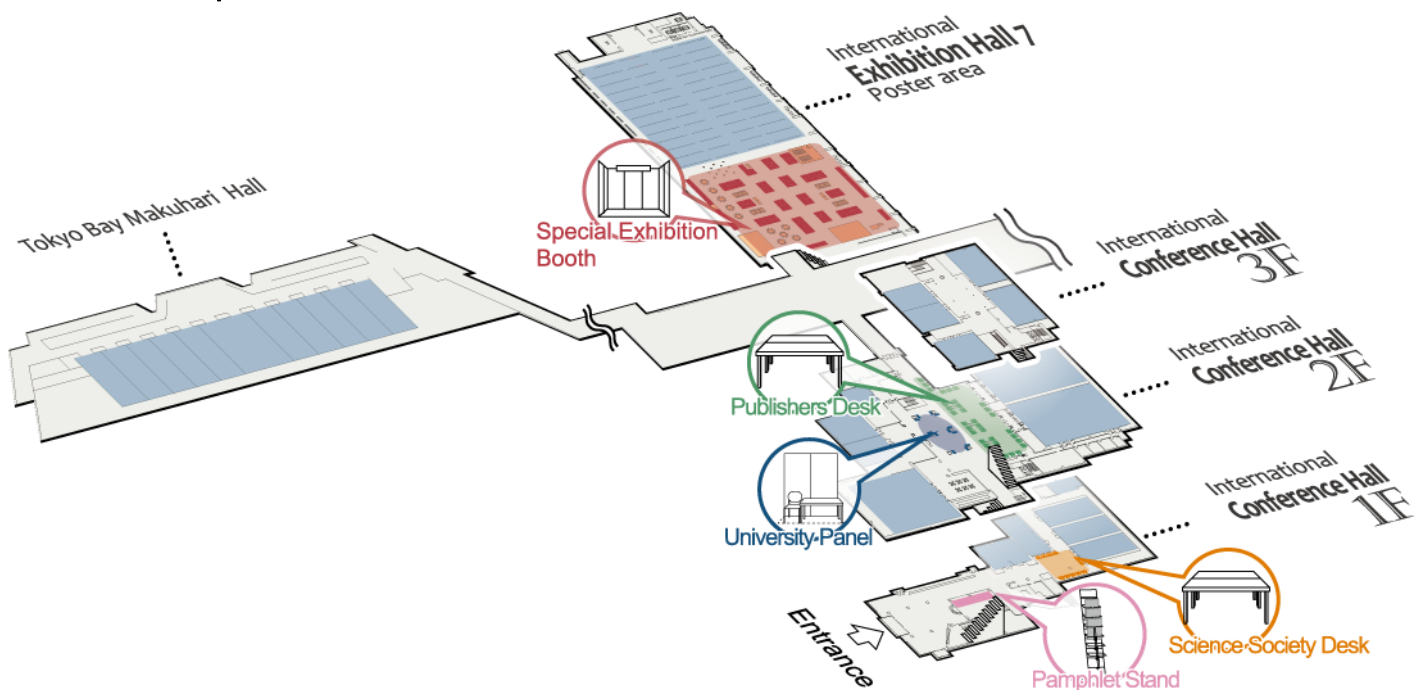

Outline of Exhibition- 3

Floor Plan

Special Exhibition Booth (Exhibition Hall 7)

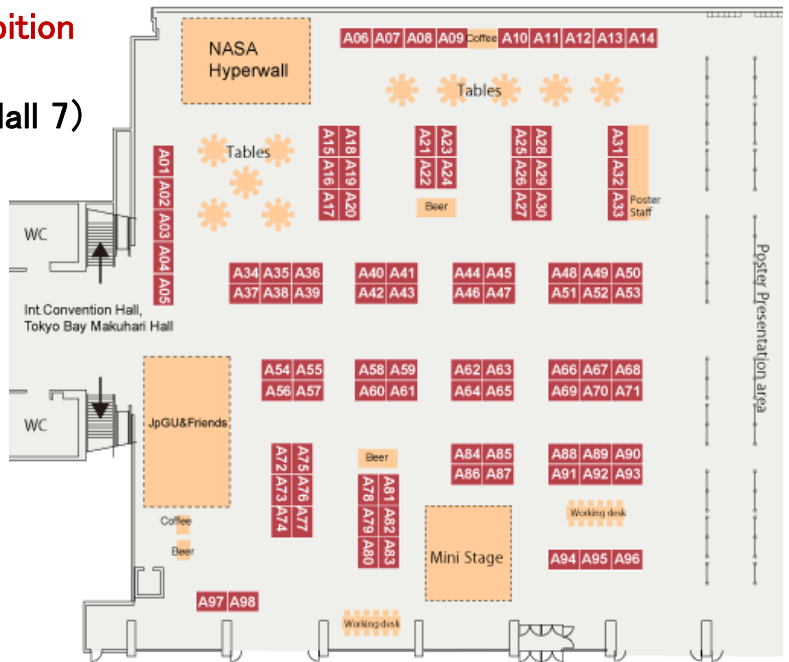

University Panel/Publishers Desk (Conference Hall 2F)

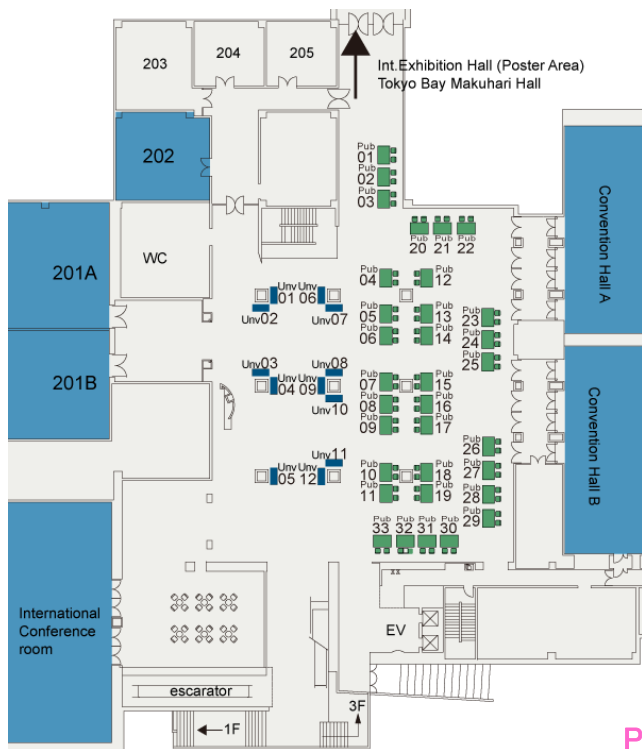

Science Society Desk (Conference Hall 1F)

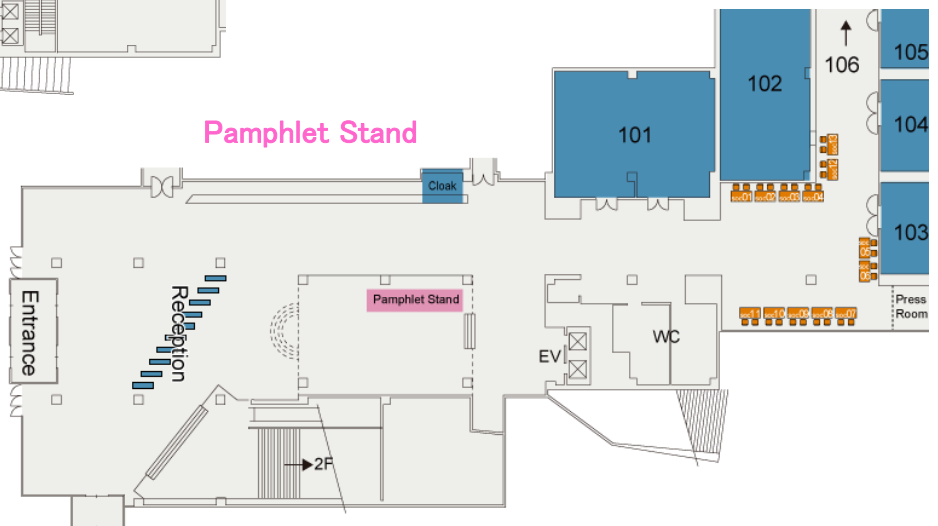

Booth Plan

Publishers Desk

Exhibition Fee : 54,000 JPY / booth

Booth

Booth Size	W180 * D250 (cm) You can arrange your tables and chairs in this area. Although the booth No.7,10,15 and 18 are about 180cm depth, because there are pillars behind them.
Equipments (included on the booth fee)	2 Tables (W180cm * D60cm * H70cm)
	2 Tablecloth (white)
	2 Chairs
	1 Name plate (W42cm * H30cm) Name of the organization will be written in Black
Passes	2 Exhibitor Pass B Permission to enter only exhibition area *No additional Pass are provided without charge.
Details	Floor is carpeted. Electrical source is not supplied.

- Options : please refer to P.8.
- Basic installation will be ready on the day before.

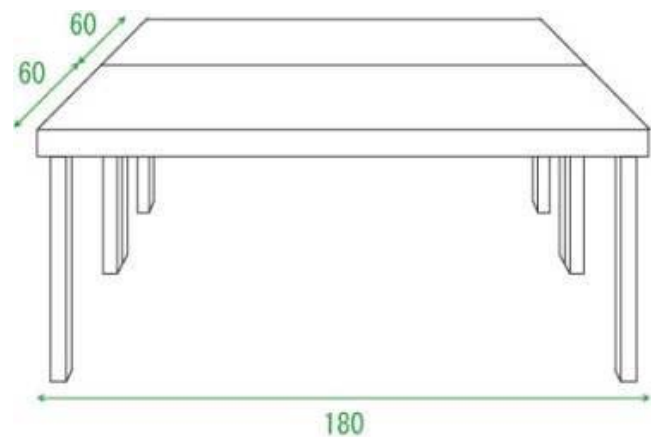

Booth Plan

University Panel

Exhibition Fee : 75,600 JPY / Panel

Booth

Booth Size	W180 * D60 * H210 (cm)
Equipments (included on the booth fee)	1set Back Panel (H180 * H210)
	1 Table (W120cm * D60cm * H70cm)
	1 Tablecloth (white)
	1 Chair
	1 Name plate (W42cm * H30cm) Name of the organization will be written in Black
Passes	1 Exhibitor Pass A Permission to enter all rooms and exhibition area 2 Exhibitor Pass B Permission to enter only exhibition area *No additional Pass are provided without charge.
Details	Back and Side Panels: Covered with cloth You can use Pins, hooks and chains. There are no hooks and chains at the venue. Please be sure to bring them by yourselves. Floor is carpeted. Electrical source is not supplied.

- Options : please refer to P.8.
- Basic installation will be ready on the day before.

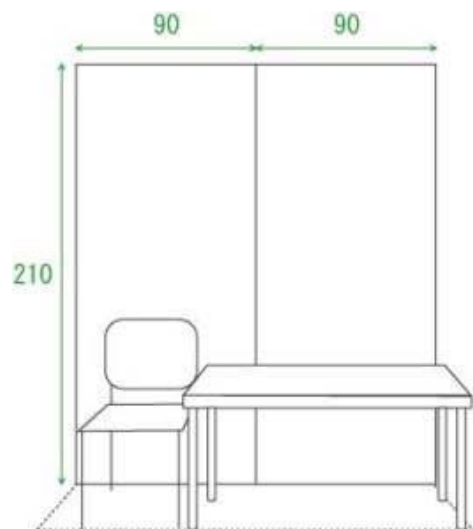

Booth Plan

Science Society Desk

Exhibition Fee: 43,200JPY / booth

Society member: 32,400JPY / booth

Booth

Booth Size	W180 * D90 (cm)
Equipments (included on the booth fee)	2 Tables (W180cm * D45cm * H70cm)
	2 Tablecloths (white)
	2 Chairs
	1 Name plate (W42cm * H30cm) Name of the organization will be written in Black
Passes	2 Exhibitor Pass B Permission to enter only exhibition area *No additional Pass are provided without charge.
Details	Floor is carpeted. Electrical source is not supplied.

- Options : please refer to the next page.
- Basic installation will be ready on the day before.

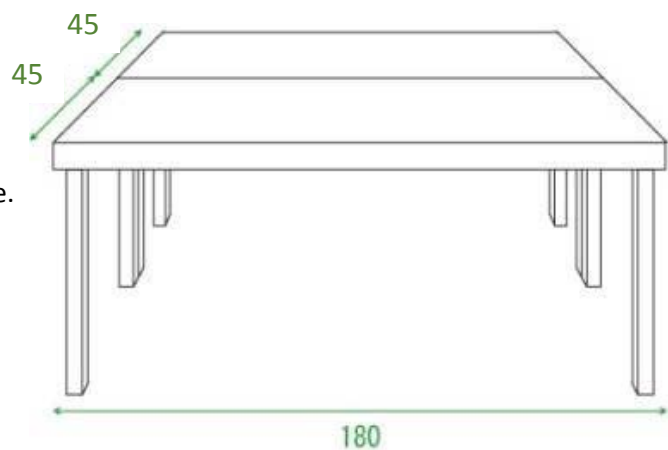

Options – 1 (Publishers Desk, University Panel, Science Society Desk)

Equipments and Fee (tax included)

Catalog stand (Desk)

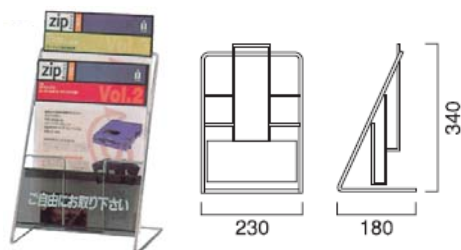

3,240 JPY
W23 * H34 * D18(cm) A4size

Catalog stand (floor)

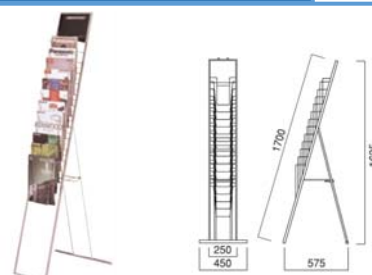

6,480 JPY
W25(bottom45) * H163.5 * D57.5(cm) A4 size

Panel stand 1

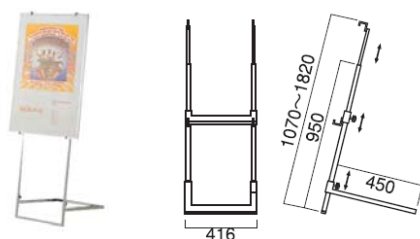

8,640 JPY
*Panels are not included
W41.6 * H107-182 * D45(cm)

Panel stand 2

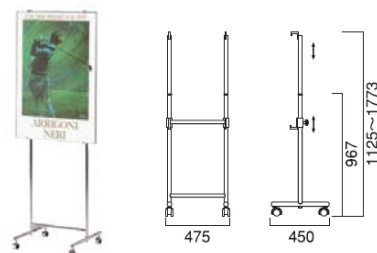

7,560JPY
*Panels are not included
W47.5 * H112.5-177.3 * D45(cm)

Arm light



3,240 JPY
Power supply and something to clip is needed

Poster board



5,400JPY
W130 × H185cm
You can use your own pins, hooks and chains.
University Panel cannot apply.

Please order through the online system
JpGU Meeting 2018 website -> Information for Exhibitors -> For exhibitors [>> Log in]
<https://www.member-jpgu.org/exhibition-booth/login/>

Options - 2 (Publishers Desk, University Panel, Science Society Desk)

Power usage

-Electrical source is not supplied. If you use electrical devices, please order through the online system (Deadline: April 13th (FRI))

Fee: 5,400JPY / 300W (single-phase 100V 50Hz, a duplex receptacle)

Order is available in unit of 300W

*Notification

The duplex receptacle we will serve is Type A



If plugs of your equipments are not this type, please bring plug converters by yourself.

They are not provided at the venue

If you have a special request such as three phase or 200V, please request an estimate.

Supplying electric power starts: May 19th (SAT)

Free Wi-Fi

- Free Wi-Fi service (11a/11g/11n) is available at lobby at the International Conference Hall.
- Information including SSID and Password will be posted at the venue.
- We don't provide configuring service. Please be responsible for security of your own PC or other devices.
- Please note that Wi-Fi service may be suspended without notice.

Precautions:

We cannot guarantee

- the safety of the connection
- connectivity and the internet speed

*Connectivity and accessibility will depend on the circumstance of the venue.

3F

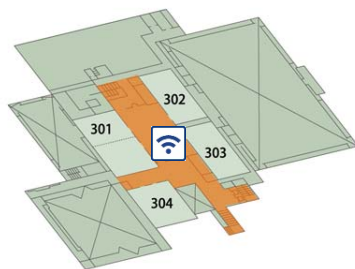

2F



1F

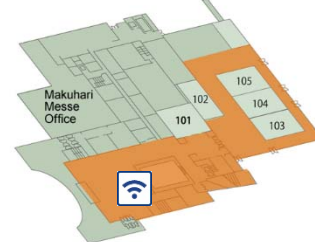

Paid Wired Internet

Public Wi-Fi is for short term use. Please send application for exclusive wired leased line for your booth.
Internet(Optical Line):86,400JPY(tax included)/line for 5 days

Please order through the online system
JpGU Meeting 2018 website -> Information for Exhibitors -> For exhibitors [>> Log in]
<https://www.member-jpgu.org/exhibition-booth/login/>

Carrying-in - 1

Date

Carrying-in on the day before and/or Carrying-in on the day is available from the date and time below.

May 19th (SAT) 3:00PM - 6:00PM Carrying-in only

May 20th (SUN) The first day 8:00AM - 10:00AM Carrying-in and installation

Please follow the guidance below.

Please notify on your "shipping notification" through online system by May 17th (THU)

<https://www.member-jpgu.org/exhibition-booth/login/>

1. By carrier agency (Domestic)

- The delivery time must be on May 19th from 3:00PM to 6:00PM or 20th from 8:00AM to 10:00AM

- Please make sure to write the delivery slips following the sample.

- Please make sure [No. / Total] are written on all packages

- Packages will be delivered to your booth.

In case you will receive your packages by yourself, please write your contact (Phone number) in the field on the "shipping notification", and please write it on the delivery slips.

- The packages might be deposited at the other place on 19th temporarily

[Delivery Slip Sample]

[Address]

2-1, Nakase, Mihama-ku, Chiba-city, 261-8550 Japan

Makuhari Messe, International Conference hall

JpGU Meeting 2018

Publishers Desk

(or University Panel, Science Society Desk)

*please write your category

Booth No. XXX-XX(Your booth number)

Exhibitor's name (as registered)

TEL:043-296-0694

[Item]

Publishers Desk (or University Panel,
Science Society Desk)

*please write your category

Items enclosed

Exhibition A- XX

Exhibitor's name (as registered)

Package No. XX / Total XX *example, No.1 / 10

Please write your cell-phone in case you
receive your package at the venue

* Notification

- Please bring delivery slips to provide against accidents.

- Installation work is allowed within your booth area and be sure not to interfere other participant and exhibitors. Please cover the floor, walls or any belongings of Makuhari Messe when you will carry-in and out your packages.

* For overseas Exhibitors

JpGU recommended Agency

Sometime customs procedure takes along time, please contact them earlier.

contact : Cargo Live Japan

16F mBAY POINT Makuhari, 1-6Nakase, Mihama-ku, Chiba-city, 261-0023 Japan

Tel : +81-43-298-4741 Fax : +81-43-298-4740

E-mail: info@cargolive.jp to: Matsute(Mr.) Subject of Email should be "JpGU2018"

In case you deliver using other company, please make sure that your packages arrive within carrying-in-period (above), and that you receive your packages there. We can NOT receive or keep your packages out of this period. Please also be informed that we will not go through procedures for custom.

Carrying-in - 2

2. By yourself

Please carry-in during May 19th (SAT, The previous day) 3:00 PM ~ 6:00PM or 20th(SUN, The first day) 8:00AM-10:00AM

All vehicles coming to the venue are required to show the [Vehicle Pass], except for major domestic carrier companies. Venue (Makuhari Messe) will issue [Vehicle Pass] at exhibitors request. Please request through online system. (Deadline: April 13th (FRI))

Carrying-in route

- See the [Vehicle Pass] for the information about carrying-in route .
- Please show the security guard the [Vehicle Pass] .

<Exhibitor Pass>

- Please wear your name tag all the time.
- Please request Passes by May 8th through online system.
- Extra Exhibitor pass is available in 1,080 JPY / person.
You can also order them through online system.
- In case you make presentation, please register as a participant not only as an exhibitor.

- How to issue

After May 9th, you can issue e-ticket for pass. Please log-in to the online system and follow the guidance to print out a barcode. You can issue your pass with the barcode at the venue.

Please order through the online system
JpGU Meeting 2018 website -> Information for Exhibitors -> For exhibitors [>> Log in]
<https://www.member-jpgu.org/exhibition-booth/login/>

Carrying-out

Carrying-out date: the last day May 24(THU) 3:30PM- 5:00PM
Please complete your dismantling work by 5:00PM.

1. Recommended Delivery Company

To domestic

- We recommend YAMATO Transport Co.,Ltd., Cash on delivery. Delivery slip will be provided at office room in Exhibition Hall 7.
Please bring your packages with written delivery slips to the collecting space by 24th 5:00PM.
- Every package needs its delivery slip on which required fields are fully filled. Packages with imperfect slips or without slips might be unshipped.
- Packages will be delivered two day later, not on the next day.

To overseas

- We recommend Cargo Live Japan.
Please contact them before the meeting.
contact : Cargo Live Japan
16F mBAY POINT Makuhari, 1-6Nakase,
Mihama-ku, Chiba-city, 261-0023 Japan
Tel : +81-43-298-4741 Fax : +81-43-298-4740
E-mail: info@cargolive.jp to: Matsute(Mr.)
*Subject of Email should be "JpGU2018"

2. Ship by yourself

- We will not intermediate your shipping.
- Please remove your belongings from your booth by 5:00PM, and delivery services should also remove your packages by 5:00PM
- In case yourself or other delivery service(ex:red caps) will do carry-out , please show [Vehicle Pass] at the East gate 2.

3.Other notes

- Although we, JpGU, will make an effort to keep your safety the though carrying-in and out, we will not take any responsibility for any damage, loss, or robbery and so on caused to exhibitors' property. Please be responsible and aware on your belongings.
- The final day May 24th (Thu)5:15PM – 6:30PM is poster core time. As Special Exhibition area and Poster presentation are at the same hall, please be careful not to interrupt the presentations.

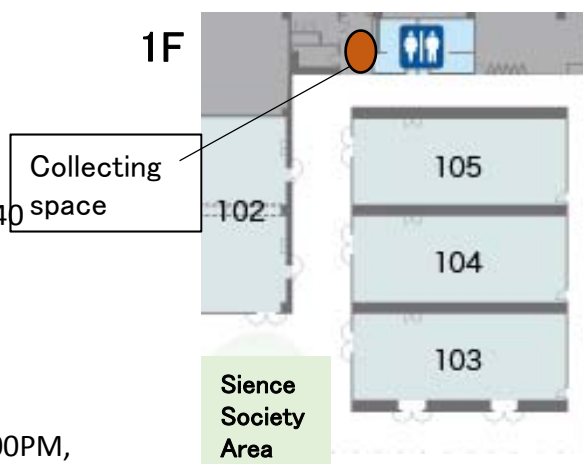
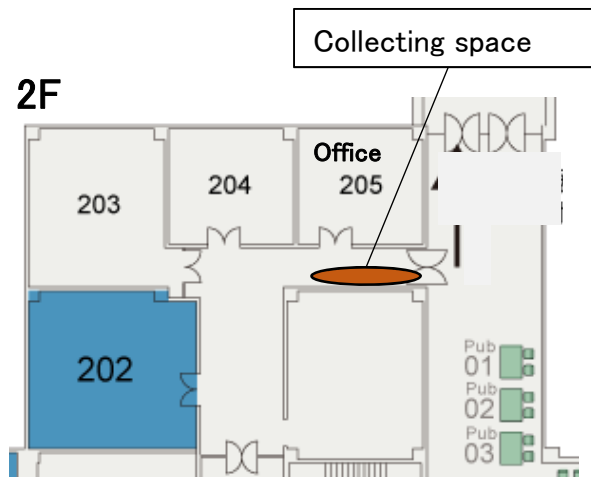

Notification - 1

Exhibitors shall observe the following regulations

1. General

- We will make every effort to ensure the security of the venue during the Meeting. However management cannot assume responsibility for damage arising from natural disaster, fire, theft, loss of property or any other cause. Please make your belongings secured by yourself, such as not to leave your valuables on the empty booth, or to use chains to fix to the booth. Exhibitors are asked to be responsible for all of their belongings and to obtain suitable insurance cover for any valuable items.
- Unfortunately there is no storage space available at the meeting venue.
- We may, due to force majeure, make major changes to the exhibition timetable or, in extreme cases, cancel exhibitions entirely. In such case part of the exhibition fee may be refunded to exhibitors. In no other case shall we be responsible for losses or expenses incurred by exhibitors.
- We reserves the right to refuse to allow any exhibition which is in their view unsuitable for JpGU Meeting.
- Subletting, selling, transferring, or exchanging exhibition space, either in whole or in part, to any third party, including other exhibitors, is prohibited.
- Please abide by the timetable given for carrying-in, showing and carrying-out exhibitions. Please contact us as soon as possible should this not be possible.

2. Exhibition Installation and Removal

- Direct work upon or modification to the floors, walls, columns, doors and other structures of the exhibition venue is prohibited. Please be careful not to damage or deface any part of the venue during carrying-in, carrying-out, and show hours.
- Exhibitors are not permitted to erect temporary ceilings or any similar structure. As a general rule the height limit for the highest point of an exhibition is 2.5m. Exhibitors who of necessity wish to exceed this limit are asked to obtain permission to do so from us in advance. We reserves the right to refuse such permission at its discretion.

- Maximum allowed load pressure on the exhibition hall floor is 360 kg/m² Those with heavy exhibits are asked to contact us in advance.
- Any potentially flammable materials used in exhibitions such as display mountings, carpeting, curtains etc. must be fireproof. Please attach a fireproof tag to all such items.
- The Japanese fire prevention law prohibits smoking, live flames, exposed elements, liquefied petroleum gas or other flammable gases, gasoline, kerosene, flammable oils and other similar hazardous objects and substances.

- Exhibitors are required to remove and suitably dispose of all of their waste and scrap materials.
- As there is no storage space available at the venue, exhibitors are asked to keep empty boxes, packaging materials, stocks etc. within their exhibition booth.
- If either we or exhibition venue staff determine that an exhibit is dangerous or is causing any other problem the exhibitor will be required to immediately take any necessary corrective measures.

Notification - 2

During Exhibition Hours

- Exhibitors are required to keep noise, vibration, smell, smoke etc. to levels which do not interfere with other exhibitors, meeting participants or venue staff.
- Exhibitors should restrict the audio volume from their booth so as not to cause inconvenience to other exhibitors and participants. If complaints are received or noise is deemed to be excessive we will require the exhibitor in question to reduce the volume. In addition to disrupting the normal progress of the meeting, excessive volume may cause serious problems in an emergency situation.
- Exhibitors are not permitted to use the space outside their booth for presentations or product exhibitions.
- If either we or exhibition venue staff determine that an exhibit is dangerous or is causing any other problem the exhibitor will be required to immediately take any necessary corrective measures.

P.R. application– 1

Exhibitors can apply for advertisement through the online system
JpGU Meeting 2018 website -> Information for Exhibitors -> For exhibitors [>> Log in]
<https://www.member-jpgu.org/exhibition-booth/login/>

Stamp Rally

Stamp Rally is a simple game for the participants. Participants collect stamps at each booth to fill their stamp card and by finishing it, they get a prize.

All you have to do is prepare small prizes, talk to the participants, give them a stamp and have fun!

[Application deadline] March 30th(Fri)(available on a first-come basis)

[Application fee] Free(Please provide prizes or small present 20pcs and bring your stamp)

*Number of exhibitors who are able to apply is limited.

Mailnews

Your P. R. is posted on our mailnews issued around April 20th or May 10th

Mailnews special issue will introduce you to our ID holders.

2 mail news are planned to be sent.

[Deadline] April 13th (FRI)

[Material format] Within 68 one-byte characters x 5 lines

[Application fee] Free

Posting your logo on our web

We will provide a free logo posting service on our web

Putting your logo on the top page of meeting website, we will introduce exhibitors.

Logo will be randomly shown.

[Deadline] April 27th (FRI)

[Sending material] via E-mail

[Material format] within 50(h)pixel * 170(w) pixel format: GIF, JPG, or PNG file.

[Application fee] Free

Digital Signage

Near the reception (International Conference Hall 1F), We will display your P.R. along with the information from JpGU on a digital signage.

[Fee] 10,800JPY /10sec.

[Deadline] May 8th(TUE)

[Format] PDF 16:9 aspect ratio, Landscape

[Sending material] via E-mail

P.R. application– 2

Banner on Mobile Apps(iPhone and Android)

Mobile Application for 2018 JpGU Meeting is getting ready. It offers Meeting information before, during, and after the meeting term.

Your banner will be shown on the bottom of the top page. Tapping your banner enables you to jump to the indicated URL.

Banner images will be replaced in every 5seconds.

Send to exhibition@jpgu.org

[Deadline] March 16th (FRI)

[Sending material] via E-mail

[Material format] 210 (h)pixel * 1536(w) pixel
format: png, eps, ai, or psd file.

[Fee]32,400JPY

reference:Use of App
for 2017 Joint Meeting

The number of Downloaded

iOS: 1,627

Android: 725

Total: 2,352

Advertisement in the Meeting Program Book

Program Book will be distributed to all participants, and it includes general information, schedule, index of authors, and other useful information. This program book is written in English.

Prints:5000(planned)

[Deadline] March 16th (FRI)

[Sending material] by email or using file transfer service

*Please send us with “[Program Book Ad]” as the subject

Send to: exhibition@jpgu.org

[Material format] pdf, eps etc.

*Program Book will be distributed to all participants

*Advertisement on covers are limited to one each.

	Full page	Half page	Quarter page
Size H × W (mm)	250 × 180	120 × 180	120 × 85
Fee	162,000JPY	81,000JPY	43,200JPY

	The inside front cover (Black and White)	The inside back cover (Black and White)	The outside back cover (Full color)
Size H × W (mm)	250 × 180	250 × 180	250 × 180
Fee	194,400JPY	194,400JPY	270,000JPY

P.R. application– 3

Advertisement in JGL

JGL is delivered to all members (if they wish) to summarize latest earth planetary science related information and provide them to researchers.

JGL is published 4 times a year in February, May, August and November.

JGL issued in May 2018 are used as program book of the Meeting.

Articles are written in Japanese.

prints:32,000 (planned)

[Deadline] March 16th (FRI)

[Material format] pdf, eps etc.

	Fee	Size (H *W)
Full page	300,000JPY	235mm × 170mm
Half page	150,000JPY	110mm × 170mm
One-third of page	100,000JPY	235mm × 52mm or 75mm × 170mm
One-sixth of page	50,000JPY	110mm × 52mm or 75mm × 80mm

Paper cup advertising

Meeting provide complimentary coffee and water for participants. Please apply to provide your original paper cup as an advertisement.

[Deadline] March 16th (FRI)

[Things you provide] Printed coffee cups * 2,000pcs

[Fee]21,600JPY/2,000pcs

[Maximum number available to provide]10,000 (2,000pcs*5days)

*Please tell us your request regarding the day your cups used.

Bar-code scanner

We will lend out a hand-held scanner which can read the bar-codes printed on participant's name tags. The participants' [name, organizations, email address, and scanning date] will be provided to you later.

[Fee]16,200JPY/scanner

[Deadline] March 16th (FRI)

*Please obtain his/her consent before scanning tag.

*Information of participants for public sessions, keynote speeches, high school and junior high school students or younger, and others are not provided.

*Please be informed that exhibitors for Pamphlet Stand can not apply.

Payment

- Booth fee and advertising fee

Booth fee and advertising fee are to be paid to Japan Geoscience Union.

You can issue the invoice through the online system by yourself.

JpGU Office will not send invoice or other bills.

Please check its amount and transfer the fee and please make payment within a month.

You can choose payment by bank transfer or by credit card.

account shown below. Please kindly contact us in case any extra procedure or documents are needed.

The bank account

SUMITOMO MITSUI BANKING CORPORATION

Koishikawa Branch

Savings account: 3761271 Japan Geoscience Union

Swift Code: SMBCJPJT

* Please bear the transfer charges.

- Fees for options

Fees for options (Fee for optional items, power, internet line, logo on name plate) are to be paid to Makuhari Messe.

The person in charge will contact you regarding details later.

- Cancellation

Cancellation is not accepted basically.

Please contact us if you need to cancel any unavoidable reason.

Please see the cancellation fees shown below.

By March 31st (SAT) 50% of exhibit fee

After April 1st (SUN) full amount

Reference: JpGU Meeting Reports

Name	Japan Geoscience Meeting 2017
Date	May 20 (SAT) - 25 (THU) , 2017
Venue	Makuhari Messe, International Conference Hall, International Exhibition Hall7 Tokyo Bay Makuhari Hall Chiba, JAPAN

The Number of Participants

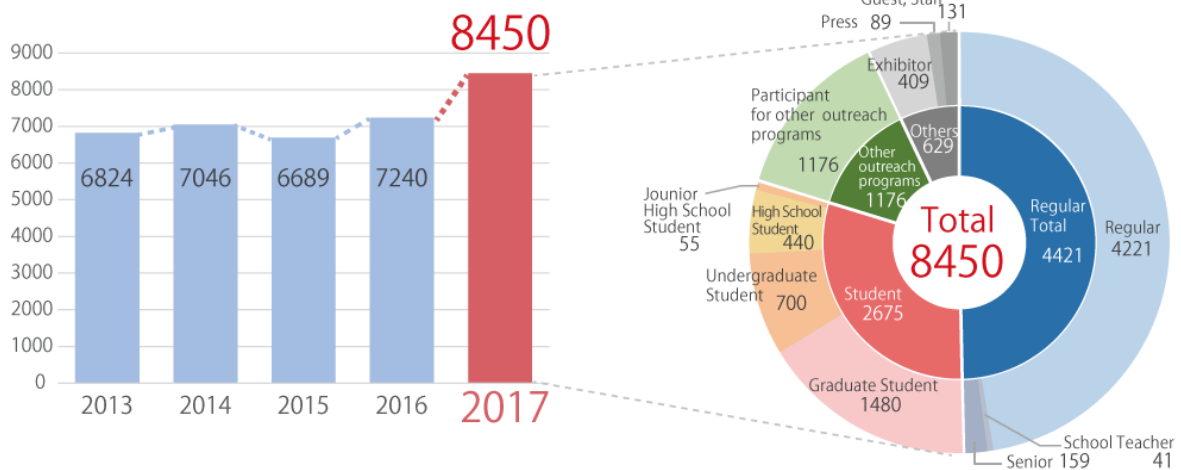

Number of participants from abroad

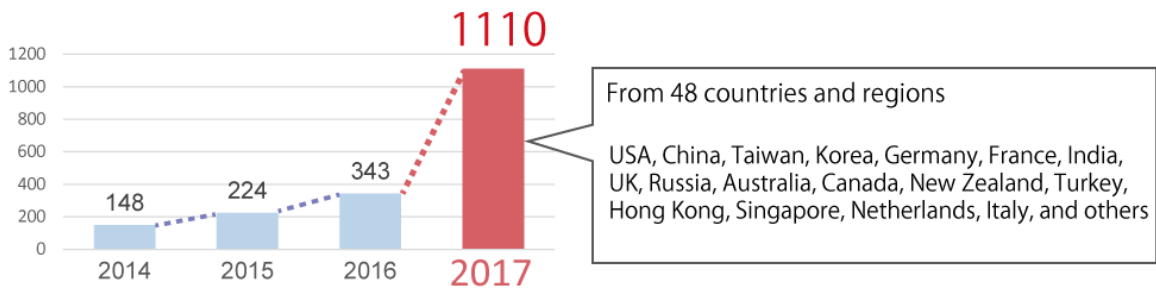

Number of presentations

