

JpGU Meeting 2016



For borderless world of geoscience

May 22 (SUN) - 26(THU) 2016

Makuhari Messe, APA Hotel & Resort Tokyo bay Makuhari, Chiba,

JAPAN 

Exhibition Guidance for Exhibition Booth (A)

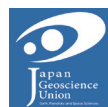

Japan Geoscience Union

as of March 01st 2016,

Index

Japan Geoscience Union Meeting 2016	1
Exhibition	Outline /Dates/Schedule 2
Carrying-in	Carrying-in / at the day before/on the day/ Vehicle Pass/Exhibitor Pass/Carrying-in route 3 - 4
Carrying-out	Carrying-out/ Other notes 5
Booth plan	 6
Options	Equipments/Power/Free Wi-Fi/Paid hard wired Internet 7 - 8
P.R. application	 9 - 10
Floor Map	 11 - 12
Payment	Other important instructions 13
Request of panel removal	 14
2015 Meeting Reports	 15

Japan Geoscience Union Meeting 2016

Greetings

The Japan Geoscience Union (JpGU) and the American Geophysical Union (AGU) are pleased to announce that as a part of our partnership, we are moving forward with an exciting multi-year meeting collaboration.

Beginning in 2016, AGU and JpGU will hold jointly sponsored sessions at each society's meeting. Session proposals for the jointly sponsored sessions at the JpGU 2016 meeting will be accepted beginning 1 September 2015. For ease of submission, in instances where AGU and JpGU colleagues are collaborating on a session proposal, we suggest that the JpGU member should submit the proposals via the JpGU website. When abstract submission begins in January 2016, both AGU and JpGU members will be able to submit abstracts.

In May 2017, JpGU and AGU will hold the first joint meeting of the two societies covering all areas of the Earth and space sciences as well as many sessions for inter- and trans-disciplinary scientists. The meeting will be in Japan, and is forecast to have 7,000-9,000 scientists from around the globe. Student travel funding will be available for these meetings.

Outline

Name	Japan Geoscience Meeting 2016
Date	May 22 (SUN) - 26 (THU) , 2016
Venue	Makuhari Messe, International Conference Hall, International Exhibition Hall
	APA Hotel & Resort Tokyo bay Makuhari
Host	Japan Geoscience Union
Society members	Association of Geography Educators of Japan,Geographic Information Systems Association of Japan,Japan Association for Quaternary Research,Japan Association of Mineralogical Sciences,Japan Cartographers Association,Japan Society of Earth Science Education,Japan Society of Engineering Geology,Japan Society of Geoinformatics,Japan Society of Hydrology and Water Resources,Japanese Association of Groundwater Hydrology,Japanese Association of Hydrological Sciences,Japanese Geomorphological Union,Japanese Society for Active Fault Studies,Japanese Society for Biological Sciences in Space,Japanese Society of Physical Hydrology,Japanese Society of Soil Physics,Meteorological Society of Japan,Palaeontological Society of Japan,Paleosciences Society,Society for Science on Form, Japan,Society of Atmospheric Electricity of Japan,Society of Exploration Geophysicists of Japan,Society of Geomagnetism and Earth, Planetary and Space Sciences,The Association for the Geological Collaboration in Japan,The Association of Japanese Geographers,The Clay Science Society of Japan,The Geochemical Society of Japan,The Geodetic Society of Japan,The Geographic Education Society of Japan,The Geological Society of Japan,The Geothermal Research Society of Japan,The Japan Society of Atmospheric Chemistry,The Japanese Association for Arid Land Studies,The Japanese Association for Petroleum Technology,The Japanese Society for Geographical Sciences,The Japanese Society for Planetary Sciences,The Japanese Society of Hot Spring Sciences,The Japanese Society of LIMNOLOGY,The Japanese Society of Snow and Ice,The Oceanographic society of Japan,The Remote Sensing Society of Japan,The Sedimentological Society of Japan,The Seismological Society of Japan,The Society for the Study of the Origin and Evolution of Life Japan,The Society of Agricultural Meteorology of Japan,The Society of Eco-Engineering,The Society of Resource Geology,The Tohoku Geographical Association,The Volcanological Society of Japan,Tokyo Geographical Society
Supporting members	Chihoutoshi convention kanrendantai office, FORTE Inc.,

Exhibition

Outline

Name Japan Geoscience Meeting 2016 Exhibition
Date May 22 (SUN) - 26 (THU) , 2016
Venue Makuhari Messe, International Conference Hall, International Exhibition Hall

Dates

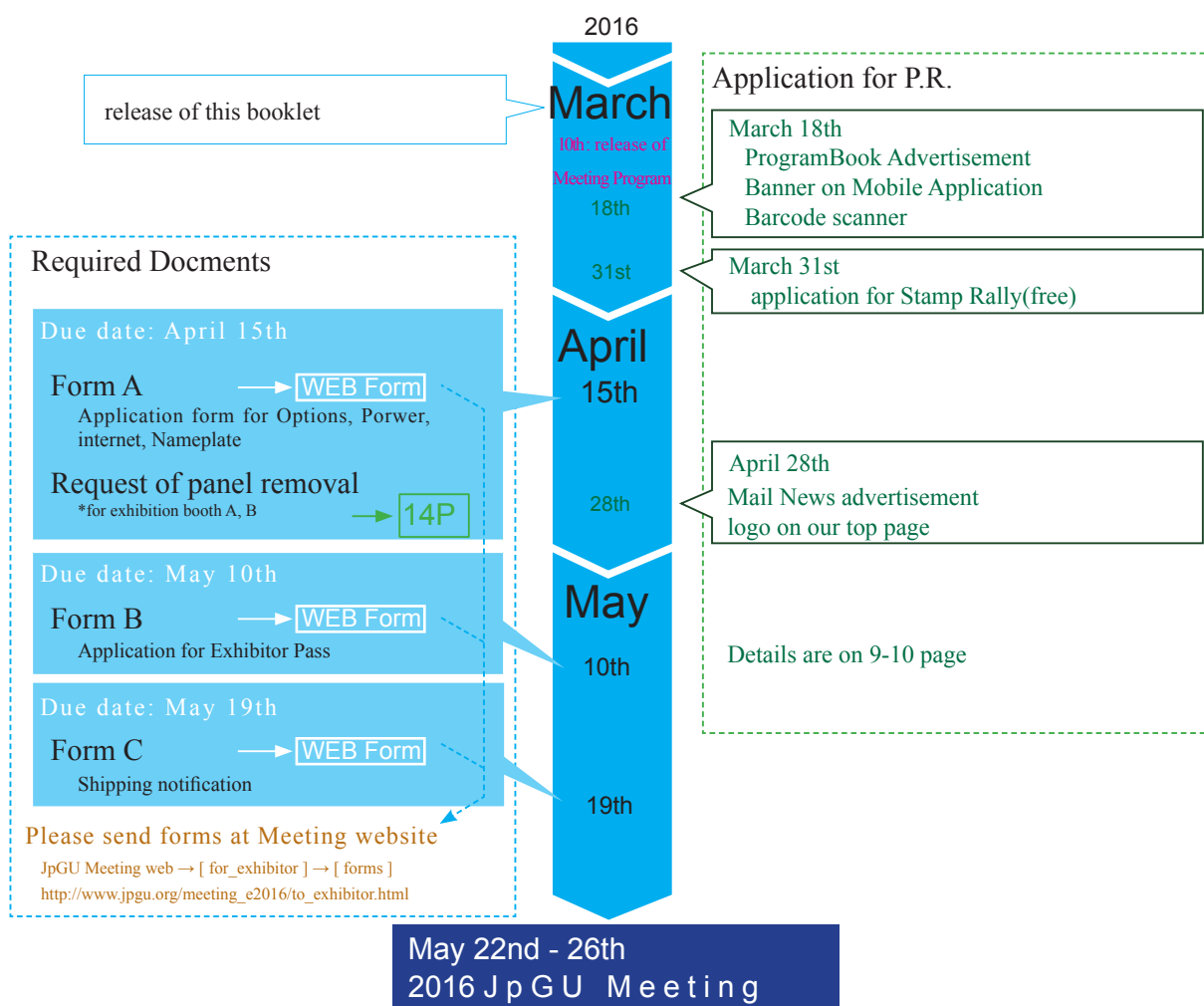

Schedule

May 21st (Sat)	Previous day	15:00~18:00	only carrying-in (instration not allowed)
22nd (Sun)	1st day	08:00~10:00 10:00~17:00*	Carrying-in and installation Exhibition Time
23rd (Mon)	2nd day	10:00~17:00*	Exhibition Time
24th (Tue)	3rd day	10:00~17:00*	Exhibition Time
25th (Wed)	4rd day	10:00~17:00*	Exhibition Time
26th (Thu)	The final day	10:00~14:00 14:00~16:00	Exhibition Time Carrying-out and removal

Whithin the time frame shown above, exhibitors can set the time freely. *18:30at the latest

Time Schedule

Oral presentation
 AM1 9:00~10:30
 AM2 10:45~12:15
 PM1 13:45~15:15
 PM2 15:30~17:00
 (on 26th most sessions end at PM1)

Poster core time
 17:15~18:30
 (26th: 15:30~16:45)

Carrying-in

Carrying-in

Carrying-in at the day before and/or Carrying-in on the day are available.
Please send a Form C (Shipping notification) by May 19th, by email.

http://www.jpгу.org/meeting_e2016/to_exhibition/form.html

JpGU Meeting web→for_exhibitor→forms

Carrying-in at the day before

When you ship packages to Makuhari Messe

- Please specify the time frame within May 21th (Sat) 15:00 - 18:00
- Please make sure to write the delivery slips following the sample shown on the right page
Please make sure [No. / Total] are written on all packages
- All vehicles coming to venue are required to show [Vehicle Pass and Parking Certification],
except for major carrier companies.
- Packages will be delivered to your booth and left there.
- In case you are going to carrying-in on the previous day but you are not
going to be there at the day,
JpGU office (or staff at venue) will receive your packages.
- In case you request to receive your packages by your self, please check
and write your contact in From C
- Please be sure that JpGU or venue assumes NO responsibility on your
packages after receiving.
- Please bring delivery slips to provide against accidents.

notification

*In case you are going to carrying-in at the previous day but you are not going to be there at the day, JpGU office (or staff at the venue) will receive your packages.

*Packages will be delivered to your booth.

*Please be sure that JpGU or venue assumes NO responsibility on your packages after receiving.

*Please bring delivery slips to provide against accidents.

Carrying-in on the day

By carrier companies

- Please make sure to write the delivery slips following the sample shown on the right page.
Please make sure [No. / Total] are written on all packages
- All vehicles coming to venue are required to show [Vehicle Pass and Parking Certification],
except for major carrier companies.
- Packages will be delivered to your booth and left there.

By yourself

- Please show [Vehicle Pass and Parking Certification] at the East gate 2.

▲ notification

- Please bring delivery slips to provide against accidents.
- Installation work is allowed within your booth area and be sure not to interfere other participant and exhibitors. And please cover the floor, wall or any belongings of Makuhari Messe in case needed, when you carry-in and out your packages.
- In case you carry heavy packages, please cover and cure the wall, floor, and other equipments of venue.

[Description Delivery Slip]

[address]

2-1, Nakase, Mihama-ku, Chiba-city, 261-0023 Japan

Makuhari Messe, International Exhibition Hal 6

Japan Geoscience union Meeting 2016

TEL:043-296-0506

(Please write your cell-phone in case you receive your package at the venue)

[item]

Items enclosed

Exhibition B - XX

Exhibitor's name (as registered)

Package No. XX / Total XX

*example, No.1 / 10

Vehicle Pass and Parking Certification

Please show [Vehicle Pass and Parking Certification] at the East gate 2.

For domestic exhibitors, certification are delivered with this booklet.

In case you are exhibitors from abroad and you need certification, please contact us.

Exhibitor Pass

→ [WEB Form B](#)

- Please bring and equip your pass trough the whole term.
- Please submit Form B by May 10th. In case you do not sed Form B, passes do not included your name.
- Extra passes only available in exhibition area will be issued in 1,080 JPY per one.
- In case you make presentation, Please register as a participant not only as an exhibitor.

[How to issue]after May 10th, a guidance mail will be sent to the registerd mail address. Please follow the guidance to print out a barcode, and please issue your pass with the barcode at the venue, on the day.

Carrying-in route

[International Exhibition Hall 6]

Please show [Vehicle Pass and Parking Certification] at the East gate 2.

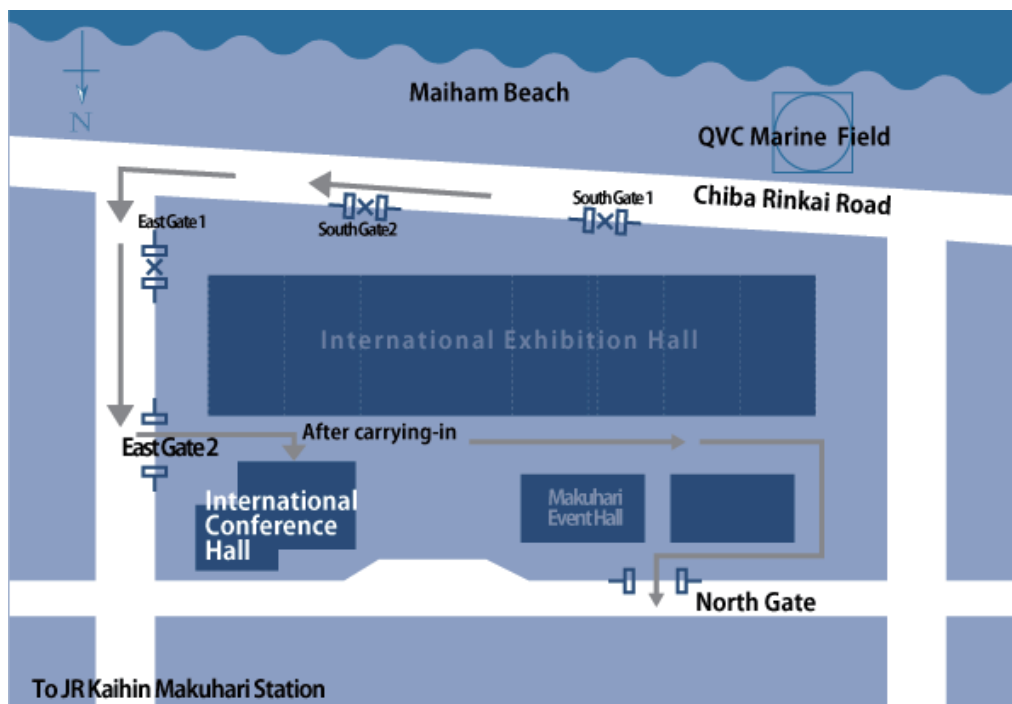

Carrying-out

Carrying-out

At the final day :May 26th (Thu)removal is to be completed by 16:00

Specified by Makuhari Messe

Delivery service specified by Makuhari Messe is recommended

(YAMATO Transport Co.,Ltd., Cash on delivery)

- Delivery slip will be provided at reception on 1F
- Please bring your packages with written delivery slips to the front of 2F 205 or next to 1F cloak by 14:45
- Packages are stored there and shipped at around 17:00
- Please arrange to send packages abroad by yourself. (YAMATO takes care of only domestic delivery.)

⚠ Every package needs its delivery slip on which required fields are fully filled. Packages with imperfect slips or without slips might be unshipped.

⚠ Domestic delivery: Packages will be delivered two day later, not in next day.

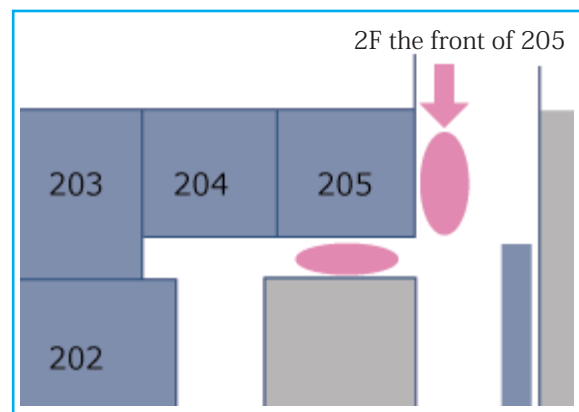
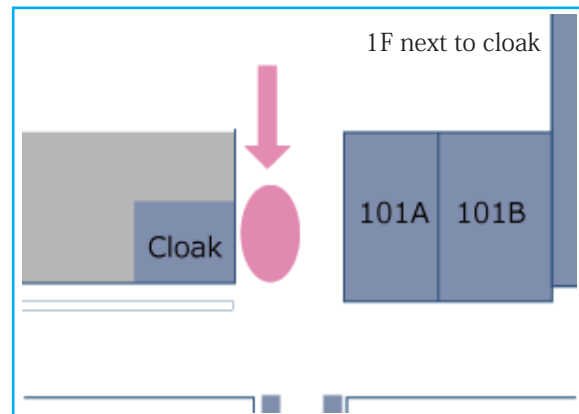

Ship by yourself

- You can use other shipping services. In that case please be responsible for everything.
- Please remove your belongings from your booth by 16:00, and delivery services should remove your packages by 17:00

Other notes

- Although we, as host, will make an effort to keep safe though carry-in and out, we will not take any responsibility for any damage, loss, or robbery and so on caused to exhibitors' property. Please be responsible and aware on your belongings.
- The final day May 28th (Thu)15:30 - 16:45 is poster core time. As Exhibition Booth B and Poster presentation are at the same hall, please take care of participants' presentation especially not to make unwanted sound.

Booth plan

Special Exhibition booth B

(International Exhibition Hall 6)

194,400JPY (including tax)

Special price only for 2016 Meeting

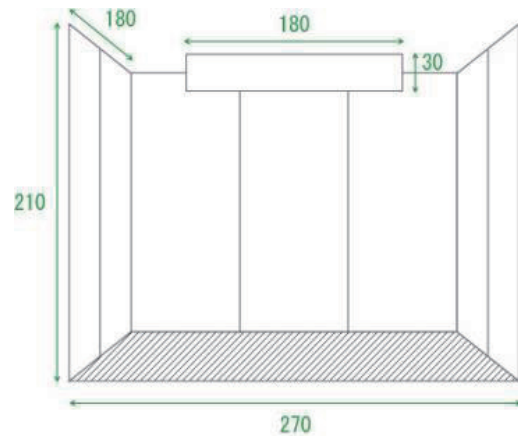

Booth composition

Size	W270cm * D180cm * H210cm
Included	Back and side panels(W270cm * D180cm * H210cm) * 1 set
	Name Panel(W180cm * H30cm) * 1
	Table(W180cm * D60cm * H70cm) * 2
	Cloth(white) * 2
	Chairs * 2
	Arm Light * 2(with clipper)
	Electrical usage and construction cost (max 500W/ 1 booth)
Passes	Exhibitor Pass (Full Conference Tickets) x 2
	Exhibitor Pass x 2
Details	Back and side panels: Covered with cloth
	(Pins, hooks and chains are available. There are no hooks and chains at the venue. Please be sure to bring them by yourselves.)
	Floor: Concrete

- Options : please refer to next page.
- Basic installation will be ready by the day before.
- Exhibitors name will be shown in black on white Name panel. In case you hope special printing including your official logo, please contact us. (extra fee will be charged)

Options

(for Exhibition booth A, B)

→ WEB Form A

Please access from Exhibitors' page on JpGU Meeting website.

Deadline April 15(Fri.)

http://www.jpgu.org/meeting_2016e/to_exhibition/form.html

Equipments

[Easel 1] 7,020 JPY

*Panels are not included
W50 * H118 * D51(cm)



[Easel 2] 4,320 JPY

*Panels are not included
W70-113 * H60-112 * D70-113(cm)



[Catalog stand (Desk)] 3,240 JPY

W23 * H34 * D18(cm) A4size

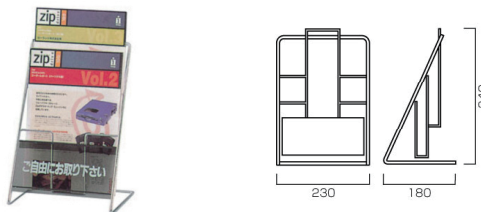

[Catalog stand (floor)] 6,480 JPY

W25(bottom45) * H163.5 * D57.5(cm) A4 size

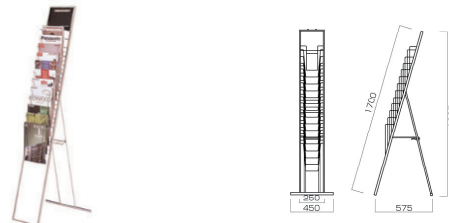

[Panel stand 1] 8,640 JPY

*Panels are not included
W41.6 * H107-182 * D45(cm)

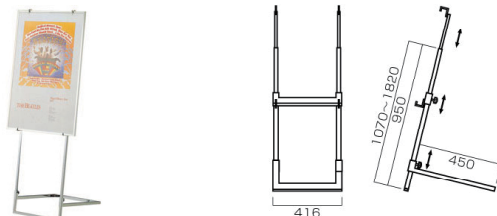

[Panel stand 2] 7,560 JPY

*Panels are not included
W47.5 * H112.5-177.3 * D45(cm)

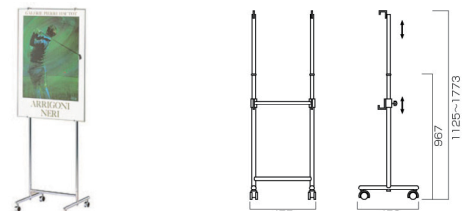

[DVD set] 41,040 JPY

a 32 inch monitor and a DVD player
Power supply needed



[32 inch monitor] 27,000 JPY

Monitor only. Power supply needed



Mini D-Sub15 pin cable available. Please request.

[Arm light] 3,240 JPY

Power supply and something to clip is needed



Power

→ [WEB Form A](#)

-Electrical source is arranged by JpGU meeting office. Electricity is supplied for only exhibition booth. Maximum supply for each booth is 500W.

-Please tell us your estimated electrical usage by sending following form to avoid troubles, by April 15th.

-Please estimate you electrical usage with some margin to avoid unexpected and serious trouble such as short circuit.

-Too much electrical usage might be declined due to the safety reasons of the convention site.

Period to supply electric power: from May 22 (Sun) 2016 ~ May 26(Thu)

Free Wi-Fi

-Free Wi-Fi service (11b/11g/11n) is available.

-Information is posted on the day.

-We don't provide setting service. And please be responsible for security of your own PC or other devices.

-Depending on the number of users, situation and spec of users' devices, places and other conditions, you might not be able to use Wi-Fi service.

-Please note that Wi-Fi service may be suspended without notice.

Reference: Wi-Fi available area (The connection is not guaranteed)

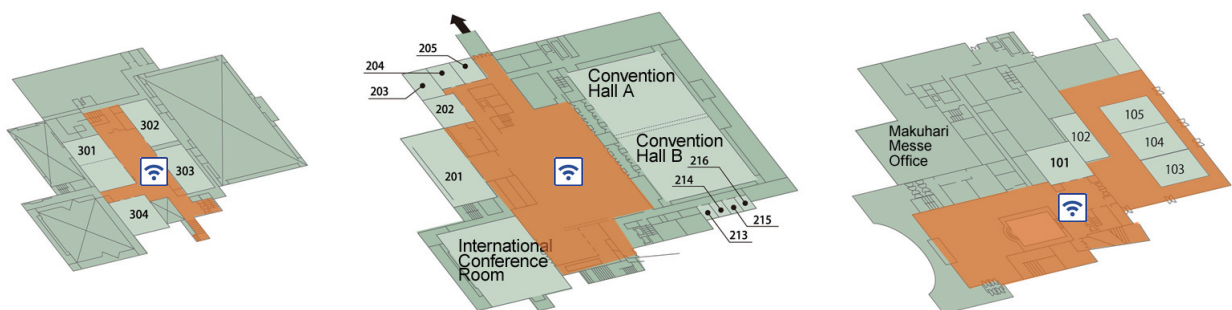

Please refer to Makuhari Messe official website (top page – Guide to Facilities – Facility Services – Wireless LAN/Wi-Fi) for other paid wireless internet services. Contract should be needed in advance by yourselves.

Paid hard wired Internet

→ [WEB Form A](#)

Public Wi-Fi cannot be used permanently. Please send application for exclusive wired leased line for your booth.

Deadline: April 15th

Internet(Optical Line):86,400JPY(tax included)/line

[WEB Form A](#)

http://www.jpгу.org/meeting_e2016/to_exhibition/form.html

2016JpGU Meeting→For exhibitors→Forms

P.R. application

Please utilize advertisement below.

Stamp Rally

This is an easy game to increase visitors to your booth. Participants for Meeting collect stamps on their stamp card at each booth. When they collected some stamps, they can get a prize or small present which are provided by each exhibitors. The details will be available later.



[Application deadline] **March 31(Thur)**(available on a first-come basis)

[Application fee] Free(Please provide prizes or small present 20pcs and bring your stamp)

[How to apply] online Form

Mail News

issued one month before and 10 days before the Meeting



Mail new special issue will introduce exhibitors to members and Meeting members, about 10,000 person.

The mail news will be sent in two parts before the Meeting.

[Deadline] April 17 (Fri)

[Sending material] online form

[Material format] Within 64 one-byte characters x 5 lines

Posting your logo on our web



Putting your logo on the top page of meeting website, we will introduce exhibitors.

[Deadline] At anytime. finally April 30 (Ths)

[sending material] by email *subject are to be [toppage data]

[Material format] 50(h)pixel * 170(w) pixel format: GIF, JPG, or png file.

Banner on Mobile Apps

(iPhone and Android)

Mobile Application for 2015 JpGU Meeting is getting ready. It offers Meeting information before, during, and after the meeting term.

Your banner will be shown on the bottom of the top page. Tapping your banner enables you to jump to indicated URL.

With every 5 seconds, banner image will be replaced.

Send to toexhibition@jpgu.org

[Deadline] by email final deadline March 20th(Fri)

[Sending material] by email *subject are to be [apps banner]

[Material format] 210 (h)pixel * 1536(w) pixel format: png, eps, ai, or psd file.

reference: Use of App for 2015 Meeting

the number of download

Android ver.	734
iOS ver.	1274
total	2008

the number of access
(total of accessed screens)

order	language	# access
1	Japanese	442579
2	English	20111
3	Chinese	7978
4	Hangul	2196
5	French	816

and Spanish, Turkey, Germany...

Advertisement in the Meeting Program Book

Program Book will be distributed to all participants, and includes general information, schedule, index by authors, and other useful information. This program book is written in English.

[Deadline] March 18th(Fri)

[Sending material] by email or using file transfer service

*subject are to be [Program Book Ad]

Send to: exhibition@jpgu.org

[Material format] pdf, eps etc.

	1page	1/2page	1/4page
seize	W180mm* H250mm	W180mm * H120mm	W85mm * H120mm
fee	162,000JPY	81,000JPY	43,200 JPY

tax included

Advertisement in JGL

JGL is delivered to all members (if they wish) to summarize latest earth planetary science related information and provide them to researchers.

JGL is published 4 times a year.They are February, May, August and November.

JGL issued in May 2016 are used as program book at Meeting.

prints:32,000 (planned)

written in Japanese.

[Deadline] March 18

[Sending material] by email or using file transfer service *subject are to be [JGL Ad]

Send to: exhibition@jpgu.org

[Material format] pdf, eps etc.

	fee	size
1 page	300,000 JPY	H235mm * W170mm
1/2 page	150,000 JPY	H110mm * W170mm
1/3 page	100,000 JPY	H235mm * W52mm or H75mm * W170mm
1/6 page	50,000 JPY	H110mm * W52mm or H75mm * W80mm

*reference : <http://www.jpgu.org/sciencemagazine/koukoku.html>

tax included

Bar-code scanner

We will lend out a hand-held scanner which can read the bar-codes printed on participant's name tags. The participants' name, organizations, mail address, and scanning date will be provided to you later.

[Deadline] March 18

[Sending material] by email

[Fee]16,200JPY/per 1

[Deliverables] Name, organization, email adress, date

Data of several kind of participants can not be delivered,

(ex, public session, high school students, and others.)

Floor Map

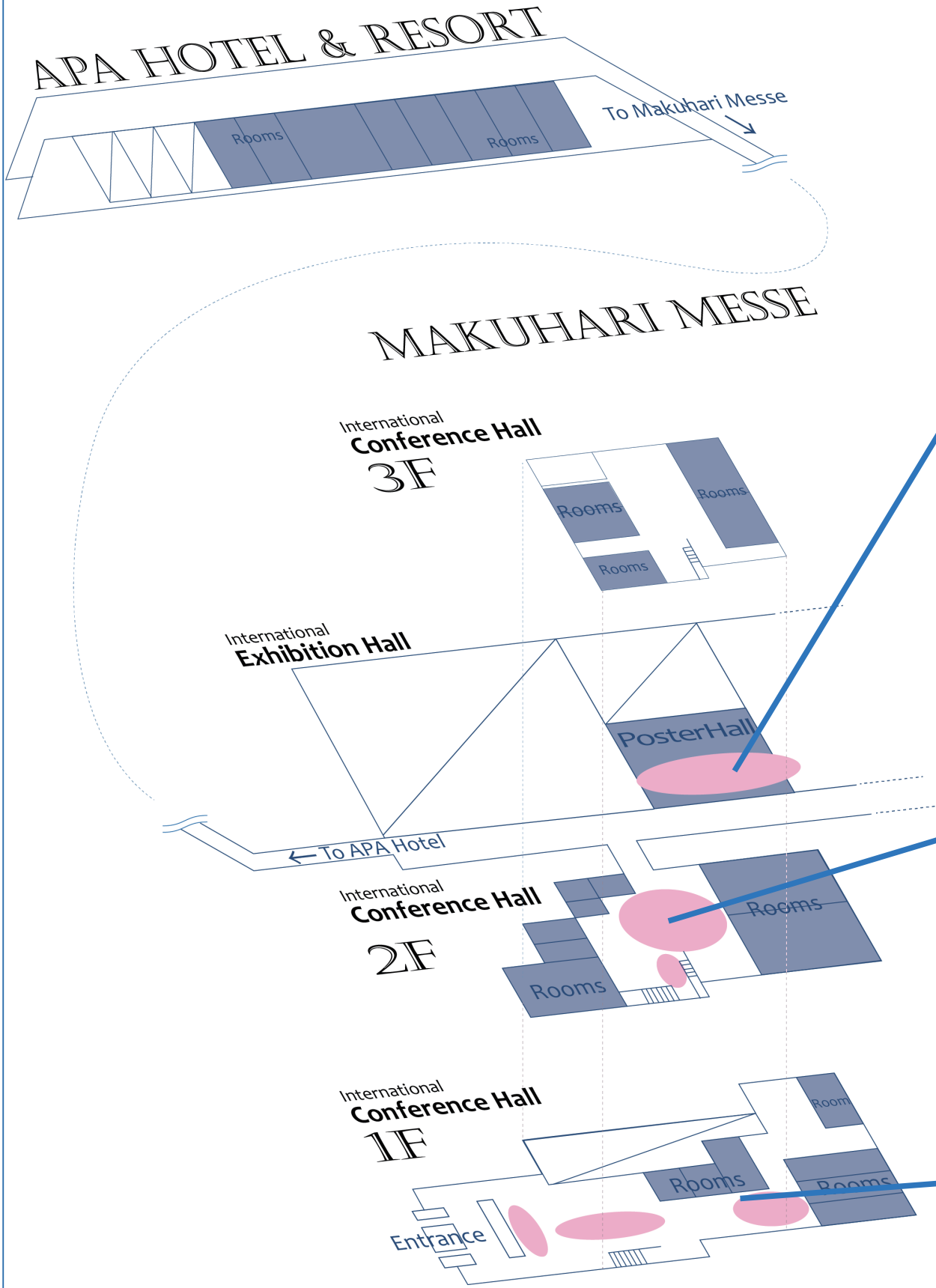

International Exhibition Hall 6

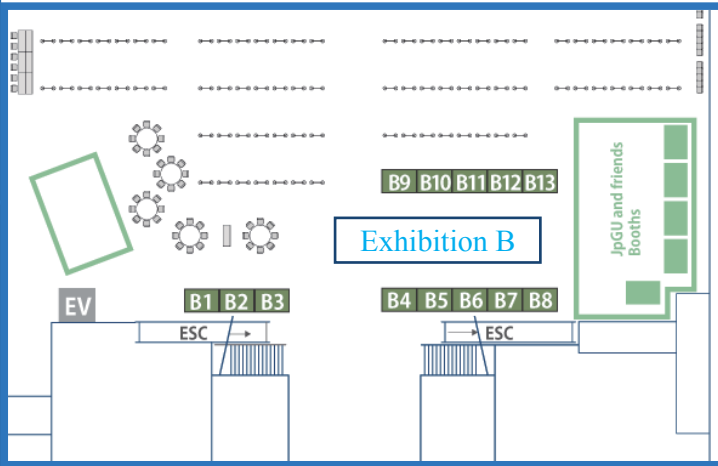

International conference hall 2F

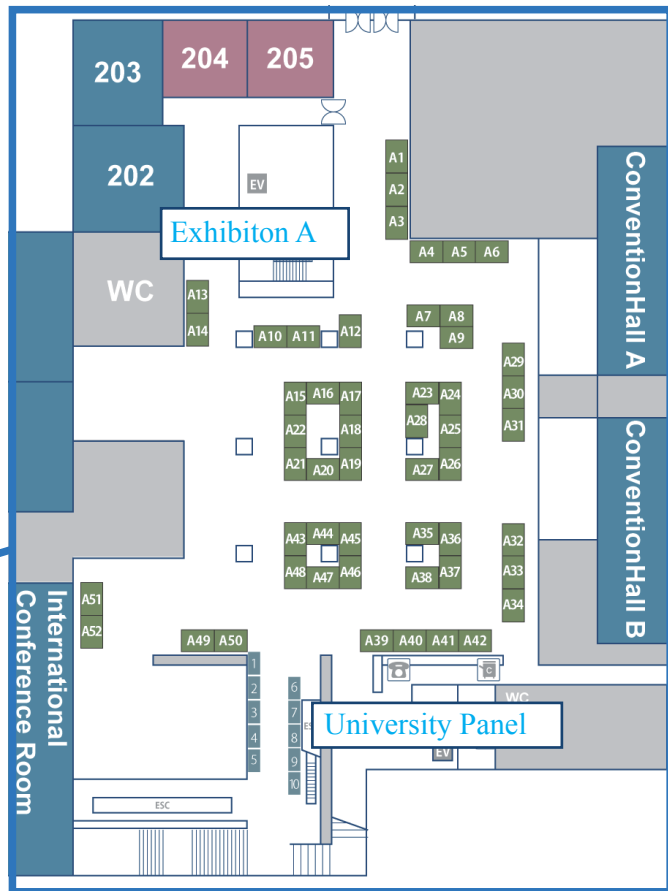

International conference hall 1F

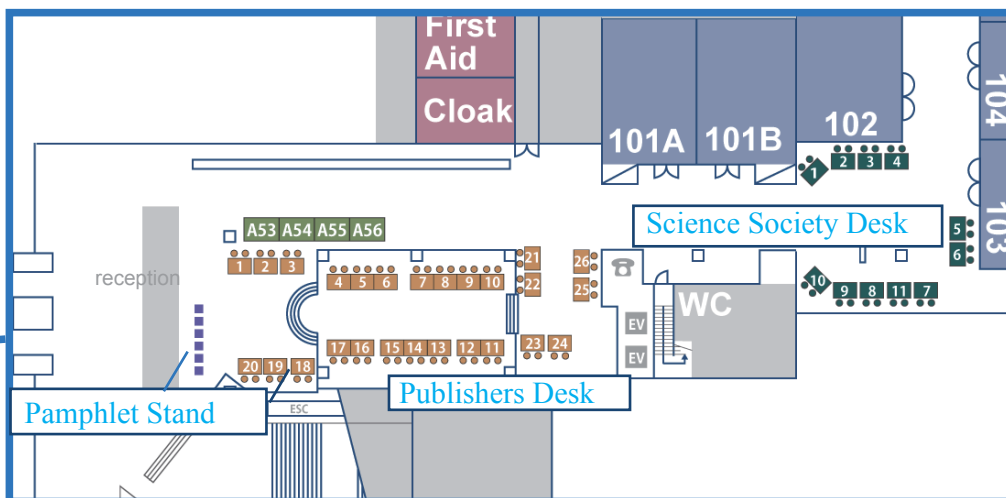

Payment

1. How to make payment

A bill is issued and sent by email.

Please check its amount and transfer the fee by April 24th (Fri) into our bank account shown below. Please kindly contact us in case any extra procedure or documents are needed.

2. The bank account

Bank of Tokyo-Mitsubishi UFJ, Ltd.

Hongo Branch

Checking account: 4661851

Japan Geoscience Union

* Please bear the transfer charges.

Swift Code: BOTKJPST

3. Cancellation

Cancellation is not accepted in principle.

Please contact us in case of force majeure.

Please see the cancellation fees shown below.

By March 31th (Tue) 50% of exhibit fee

After April 1st (Wed) full amount

Other important instructions

1. Posting bills

Please note that posting bills are not allowed at the convention site.

2. Audio Visual devices

Using microphones is not allowed.

Please adjust the volume of audio visual devices in case you use them in your booth.

Please do not turn up the volume too much. It will intervene in other exhibitors' activity, academic presentation, and announcement in emergency.

3. Insurance

Although we, as host, will make an effort to keep your belongings safe during our Meeting, we will not take any responsibility for any damage, loss, or robbery and so on caused to exhibitors' property. Please be responsible and aware on your belongings.

Exhibitor shall obtain necessary insurance.

There are no space for storage.

4. Fire prevention

It is strongly prohibited to put any goods around fire extinguishers, fire hydrants, emergency exits and warehouses. All of your materials, including cardboards are to be kept in your booth.

According to the fire prevention ordinance regulations, smoking, used of naked fire, carrying flammable goods, carrying dangerous goods are prohibited.

5. Garbage

Please be responsible to remove all of your

scrapped scrap materials by yourself.

6. Heavy objects

If you have heavy objects, please inform us.

reference: withstand load

International Conference hall 360kg/m²

International Exhibition hall 6 : 5t/m² at the maximum(except for pit)

7. Cancellation of the Meeting

JpGU Meeting office may change the exhibition period or cancel exhibition due to force majeure. In such case a part of the exhibit fee may paid back to exhibitors.

JpGU Meeting office shall not be responsible for loss or expenses in exhibitor in other case including change of detail on meeting.

JpGU office may decline exhibition by the exhibitors supposed to be unsuitable for JpGU Meeting

Request of panel removal

IF your booth include panels which is NOT adjacent to the next booth, please submit this document.

(If your booth are betwee other booths, you don't need submit this document.)

Due Date	April 15 (Fri)
address	FAX +81-3-6914-2088 or email exhibition@jpgu.org

booth	Exhibition B	No.	
Exhibitors Name			
Name			
TEL			
mail address			

<p>Panel to remove</p> <p>If your booth include panels which is NOT adjacent to the next booth, please tell us whether the panels are to be stayed or removed.</p>	<p>Please circle the appropriate one</p> <p>No (All panels are to be stayed)</p> <p>Yes (Remove a panel or panels)</p> <p>↓ Please draw each panels</p> <div style="border: 1px solid black; height: 150px; width: 100%;"></div> <p>Layout inside of booths are not needed.</p>
---	---

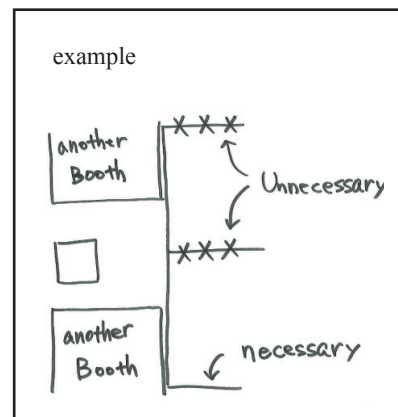
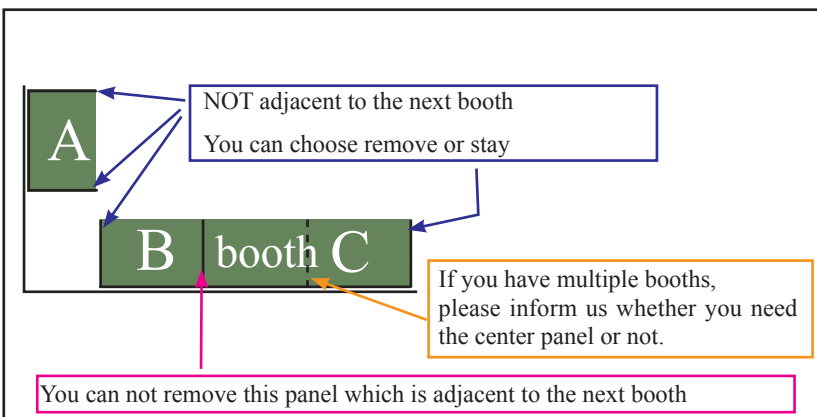

2015 Meeting Reports

	2015	2014	2013	2012	2011
Sessions total (intentional)	189(55)	193 (43)	180(42)	174(42)	174(41)
Space and Planetary Sciences	23 (12)			7 (2)	
Atmospheric and Hydrospheric Sciences	22 (9)			5 (0)	
Human Geosciences	24 (8)			5 (1)	
Solid Earth Sciences	62 (16)			31 (5)	
Biogeosciences	10 (2)				
Union session					
Public					
Education and Outreach					
Multidisciplinary and Interdisciplinary					
Abstracts Total	4037	3806	3980	3876	4044
Oral	2545	2428	3226	1975	2354
Poster	1492	1378	1754	1901	1685
Participants	6689 Participants from abroad : 224 (32 countries and regions)	7046	6824	7318	5809

Exhibitors: (the number of booths)
 Exhibition Booth: 65
 University Information Panels: 11
 Publishers and related goods: 26
 Pamphlet Stand: 7
 Science Society Area: 10

Press:
 63 companies and groups (84 persons)
 TV programs, Newspapers, Scientific journals, Publishers, and others...

	Japan Geoscience Meeting 2015
Date	May 24 (SUN) - 28 (THU) , 2015
Venue	Makuhari Messe, International Conference Hall APA Hotel & Resort Tokyo bay Makuhari Chiba, JAPAN

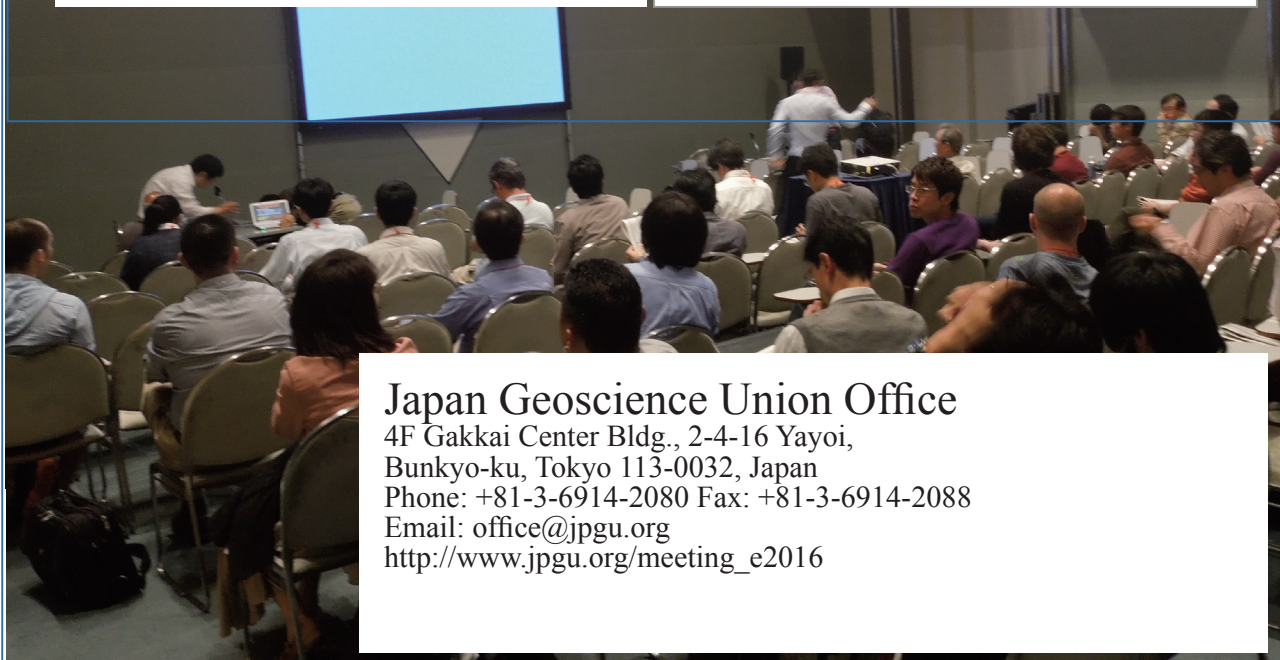
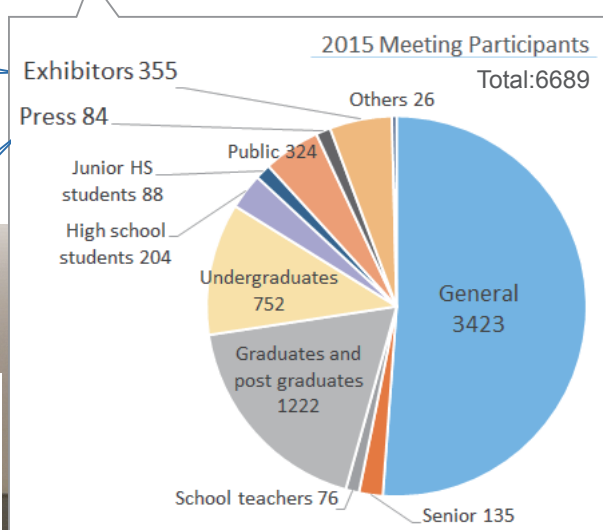

Japan Geoscience Union Office
 4F Gakkai Center Bldg., 2-4-16 Yayoi,
 Bunkyo-ku, Tokyo 113-0032, Japan
 Phone: +81-3-6914-2080 Fax: +81-3-6914-2088
 Email: office@jpgu.org
http://www.jpgu.org/meeting_e2016